

3 dB Fixed Attenuator, BNC Plug (Male) to BNC Jack (Female) Rated to 1 Watts Up to 2 GHz

FA-B1B25A-2G1W3 / H33-H3

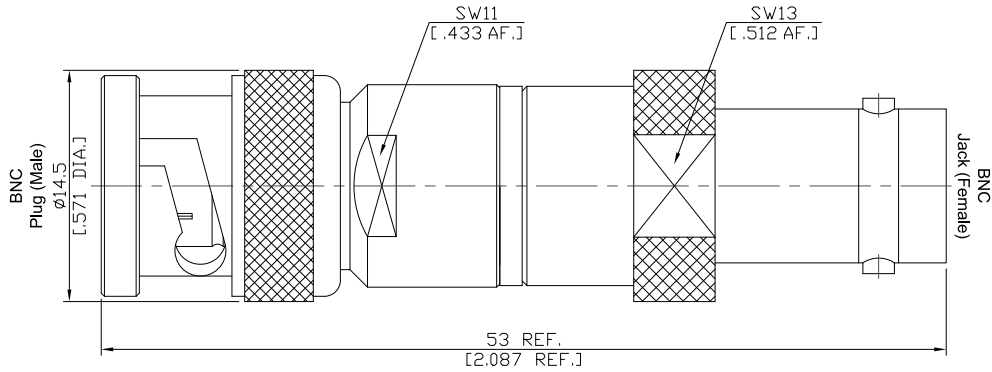

All dimensions are in mm [inch]
Tolerances according to DIN ISO 2768-mH

Interface

According to IEC 61169-8; CECC 22120; MIL-PRF-39012; MIL-STD-348B/301; BS 9210 N 004

Electrical Data

Impedance 50 Ω
Frequency DC to 2 GHz
VSWR (Return Loss) ≤ 1.2 (≥ 20.83 dB)
Average power at 25°C 1 W

Accuracy Of Attenuation & Power

Nominal Attenuation (dB)	3
Deviation (\pm dB)	0.3

Material And Plating

Piece Parts (BNC)	Material	Plating
Centre contact	Phosphor Bronze	Gold plating (Non-magnetic nickel-phosphorus underplating)
Body	Brass	Nickel
Insulator	PTFE	
Gasket	Silicone Rubber	
Coupling nut	Brass	Nickel
Piece Parts (BNC)	Material	Plating
Centre contact	Phosphor Bronze	Gold plating (Non-magnetic nickel-phosphorus underplating)
Body	Brass	Nickel
Insulator	PTFE	

Mechanical Data

Coupling Mechanisms Bayonet-lock
Mating Cycles ≥ 500
Center contact captivation: axial ≥ 15 N

Environmental Data

Temperature Range -65°C to +125°C
RoHS compliant

Packing

Single or 100