

SMA Right Angle Bulkhead PCB through Hole Mount Jack

SMA2IA59-2980A/91

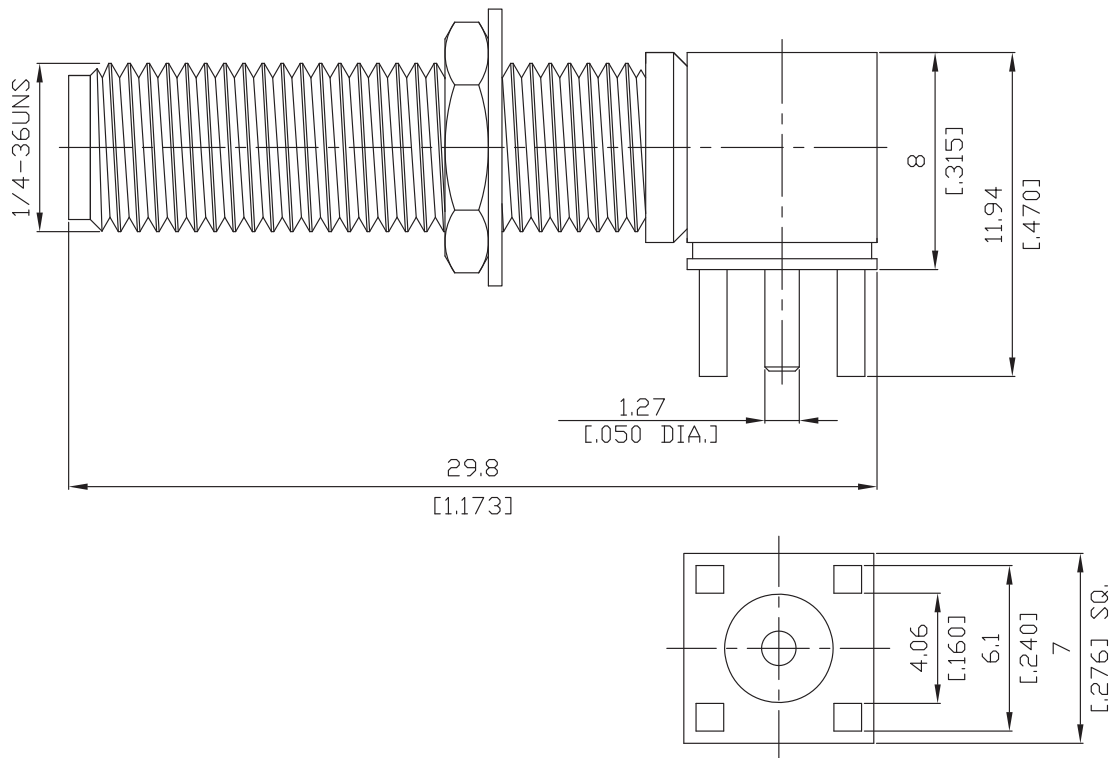

All dimensions are in mm [inch]

**Interface**

According to IEC 60169-15; MIL-C-39012; MIL-STD-348A/310

**Electrical Data**

Impedance 50 Ω  
Frequency DC to 18 GHz  
VSWR ≤ 1.15 + .015F (GHz); (≥23.1 dB)

**Mechanical Data**

Coupling mechanisms Screw-lock  
Board mounting type Through Holes  
Weight 0.0065 kg

**Environmental Data**

Temperature range -65°C to +165°C  
RoHS compliant

**Material And Plating**

Connector parts	Material	Plating
Centre contact	Beryllium Copper	Gold plating(Nickel underplated)
Body	Brass	Gold plating(Nickel underplated)
Insulator	PTFE	
Fastening nut	Brass	Gold plating(Nickel underplated)
Washer	Brass	Gold plating(Nickel underplated)

**Packing**

Single or 100

**Related Document**

Mounting Dimension MD29 & MD92