

SMA Right Angle Bulkhead PCB through Hole Mount Jack

SMA2IA59-2835A/91

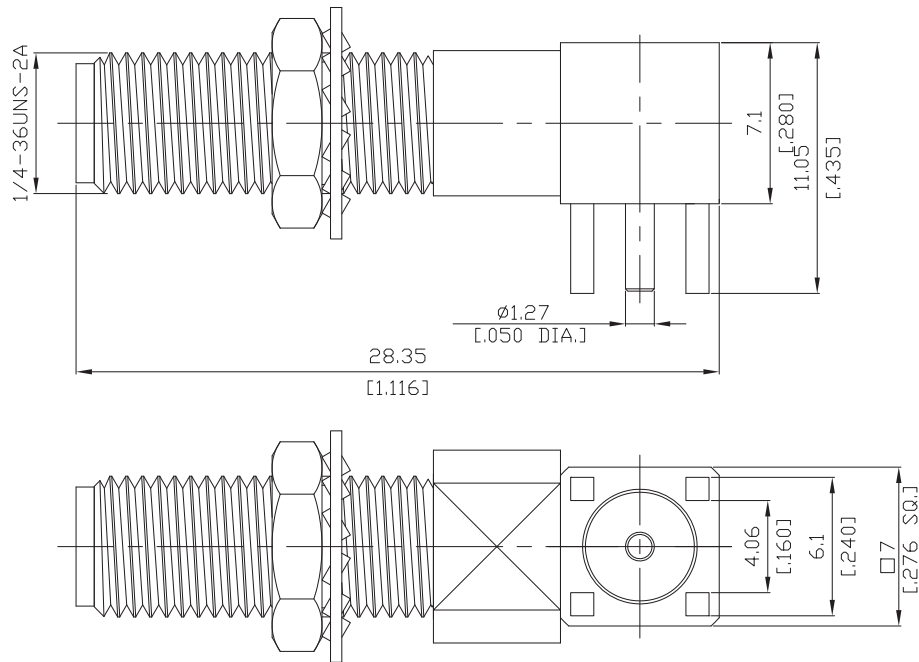

All dimensions are in mm [inch]

Interface

According to IEC 60169-15; MIL-C-39012; MIL-STD-348A/310

Electrical Data

Impedance 50 Ω
Frequency DC to 18 GHz
VSWR ≤ 1.15 + .015F (GHz); (≥23.1 dB)

Mechanical Data

Coupling mechanisms Screw-lock
Board mounting type Through Holes
Weight 0.0069 kg

Environmental Data

Temperature range -65°C to +165°C
RoHS compliant

Material And Plating

Connector parts	Material	Plating
Centre contact	Beryllium Copper	Gold plating(Nickel underplated)
Body	Brass	Gold plating(Nickel underplated)
Insulator	PTFE	
Fastening nut	Brass	Gold plating(Nickel underplated)
Washer	Brass	Gold plating(Nickel underplated)

Packing

Single or 100

Related Document

Mounting Dimension MD29 & MD92